

# Packaging

**The Junior Tool**

Stock Code	Model No.	UIC No.	Description
AR00039	C002	13002	The Jr. Tool for applying Jr. Smooth I.D. Clamps Pkg Qty 1 Weight 5.7Lbs 2.6kg



AR00039

**Center Punch Clamps & Tools Sign Mounting Brack-Its**

**Center Punch Tools**  
These ratchet action tensioning tools are for applying Center Punch and Center punch lock.



Center Punch Tool - S038  
AR00044



Center Punch Tool - T300  
AR00040

**Center Punch Tools**

Stock Code	Model No.	UIC No.	Description	Pkg Qty	Weight	
					Lbs	kg
AR00040	T300	34300	For 1/8" (15.88mm) Wide Clamps	1	3.15	1.5
AR00041	T301	34301	For 3/8" (9.53mm) Wide Clamps	1	3.15	1.5
AR00042	S032	30032	3/8" Adapter Insert for T300 Tool	1	.02	.01
AR00043	T256	34256	Mallet (Forged Steel)	1	2.05	.9
AR00044	S038	30038	For 3/8" (9.53mm) and 5/8" (15.88mm) Wide Clamps	1	1.10	.5

**Strapping Machine**

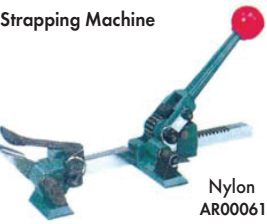

Nylon  
AR00061



Steel  
AR00060

**Strapping Steel Clip Nylon Clip**

Stock Code	Size
AR00062	5/8"
AR00063	3/4"
AR00064	1 1/4"

Stock Code	Size
AR00065	5/8"

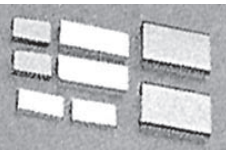

AR00062

**Steel Strap**

Stock Code	Size
AR00066	5/8"
AR00067	3/4"
AR00068	1 1/4"



AR00066

**Nylon Strap**

Stock Code	Size
AR00069	5/8"



AR00069

**Sign Mounting Brack-Its**  
BAND-IT Sign Mounting Brack-Its are used to mount traffic signs securely with BAND-IT Band and Buckles, Valustrap, Valustrap Plus or Free-End clamps.

**1-Bolt Straight Leg Brack-It**  
.075" Thick 1.9mm Packaging Quantity-50

Stock Code	Model No.	UIC No.	Description	Weight	
				Lbs	kg
AR00051	D001	14001	Stainless Steel with SS Bolt Washer and Fiber Washer	7.3	3.3
AR00052	D004	14004	Stainless Steel, No Bolt or Washer	5.9	2.7
AR00053	D011	14011	Zinc Plated Steel with Carbon Bolt, Washer and Fiber Washer	7.6	3.5
AR00054	D014	14014	Zinc Plated Steel, No Bolt or Washer	6.2	.28



AR00051

**1-Bolt Flared Leg Brack-It**  
.075" Thick 1.9mm

Stock Code	Model No.	UIC No.	Description	Weight	
				Lbs	kg
AR00055	D021	14021	Stainless Steel with SS Bolt and Washer	7.6	3.3
AR00056	D022	14022	Stainless Steel, No Bolt or Washer	6.0	2.7
AR00057	D031	14031	Zinc Plated Steel with Carbon Bolt, Washer and Fiber Washer	7.4	3.5
AR00058	D032	14032	Zinc Plated Steel, No Bolt or Washer	6.0	.28



AR00055

**Gun Tacker**  
Rapid 19 is the smallest and lightest hammer tacker in the world. One-hand grip with perfect balance. Made completely of steel. A flexible and effective tool when you want to staple insulation materials, posters, plastic sheeting, labels and other light material to large surfaces.



AR00070

Loading Capacity:  
156 fine-wire staples  
Staple Type:  
Rapid Fineline  
Rapid Fineline 13, 4-6 mm  
Weight: 360 g  
Swedish quality



Loading Capacity:  
156 fine-wire staples  
Staple Type:  
Rapid Fineline  
13, 4-6-8 mm  
Weight: 530 g  
Swedish quality



AR00071



Rapid 23 is a handy, easy-to-use staple gun, made completely of steel. High impact force. Recoilless action. Bottom loading - no loose parts. handle with safety catch to prevent blind firing. Rapid 23 is suitable for a number of tasks, such as stapling of fabric, plastic, rubber, leather, cardboard, etc., to wood.

Loading Capacity:  
156 fine-wire staples  
Staple Type:  
Rapid Fineline  
13, 6-8-10-14 mm  
Weight: 820 g  
Swedish quality



AR00072



Rapid 33 is a powerful, sturdy staple gun, made completely of steel. The adjustable impact force gives perfect stapling of both thin and thick materials, to both hard and soft underlays. Recoilless action. Bottom loading - no loose parts.

Rapid 213 Electric  
Electric staple gun  
13/8-20 mm  
Brads 300/16-20 mm



AR00073

**Bullet**

Stock Code	Model
AR00074	No 13/8
AR00075	No 13/14

# Packaging

## Plastic Sheet

Stock Code	Size mm
AR00139	0.08
AR00140	0.15
AR00141	0.2
AR00142	0.5

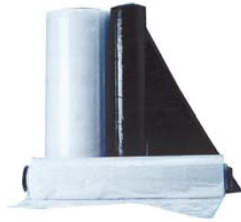

AR00139

## Cotton Twine

Stock Code	Size mm
AR00167	No. 2
AR00168	No. 10
AR00169	NO. 16



AR00167

## Nylon Rope

Stock Code	Size mm	Stock Code	Size mm
AR00143	2	AR00150	5/8"
AR00144	1/8"	AR00151	3/4"
AR00145	3/16"	AR00152	7/8"
AR00146	1/4"	AR00153	1"
AR00147	5/16"	AR00154	1 1/8"
AR00148	3/8"	AR00155	1 1/4"
AR00149	1/2"		



AR00143

## Blue and White Canvas Sheet / Canvas Roll

AR00170



Stock Code	Size	Stock Code	Size
AR00170	6' x 8'	AR00187	18' x 24'
AR00171	8' x 8'	AR00188	18' x 30'
AR00172	8' x 10'	AR00189	20' x 20' (6m x 6m)
AR00173	8' x 12'	AR00190	24' x 24'
AR00174	10' x 10' (3m x 3m)	AR00191	20' x 30'
AR00175	10' x 12'	AR00192	20' x 40' (6m x 12m)
AR00176	10' x 15'	AR00193	20' x 50'
AR00177	10' x 20' (3m x 6m)	AR00194	20' x 60'
AR00178	10' x 30'	AR00195	30' x 30'
AR00179	12' x 12' (3.5m x 3.5m)	AR00196	30' x 40'
AR00180	12' x 15'	AR00197	30' x 50'
AR00181	12' x 16'	AR00198	30' x 60'
AR00182	12' x 18'	AR00199	40' x 40'
AR00183	15' x 15' (4.5m x 4.5m)	AR00200	50' x 50'
AR00184	15' x 20'	AR00201	50' x 70'
AR00185	15' x 30'	AR00202	60' x 60'
AR00186	18' x 20'	AR00203	Blue/White CANVAS Roll

## Manila Rope

Stock Code	Size	Stock Code	Size
AR00156	2mm	AR00162	1/2"
AR00157	1/8"	AR00163	5/8"
AR00158	3/16"	AR00164	3/4"
AR00159	1/4"	AR00165	7/8"
AR00160	5/16"	AR00166	1"
AR00161	3/8"		



AR00156

## Marking Ink



AR00076

Lin Roller  
AR00077



Fountain Roller  
AR00078

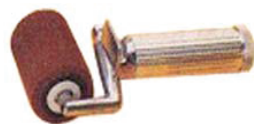

## Masking Tape

Stock Code	Size
AR00079	1/2"
AR00080	1"
AR00081	1 1/2"
AR00082	2"
AR00083	2 1/2"
AR00084	3"



AR00079

## Cloth Tape

Stock Code	Size
AR00085	1/2"
AR00086	1"
AR00087	1 1/2"
AR00088	2"
AR00089	2 1/2"
AR00090	3"



AR00085

## Opp Tape

Stock Code	Size
AR00091	2"



AR00091

## Double Sided Tape

Stock Code	Size
AR00092	1/2"
AR00093	1"
AR00282	3/4"



AR00092

## Double Sided Sponge Tape

Stock Code	Size
AR00094	1/2"
AR00095	1"
AR00283	3/4"

# Packaging

**Filament Tape**

Stock Code	Size
AR00096	1/2"
AR00097	1"

AR00096



**Red/White Safety Tape**

Stock Code	Size
AR00120	2"
AR00121	3"

AR00120



**Yellow/Black**

Stock Code	Size
AR00122	2"
AR00123	3"

AR00122



**Scott Tape**

Stock Code	Size
AR00098	1/2"
AR00099	3/4"

AR00098



**Telfon Tape**

Stock Code	Size
AR00248	1/2"
AR00249	1"

AR00248



**Floor Tape**

Stock Code	Size
AR00100	2"
AR00101	3"

AR00100



**Electrical Tape**

Stock Code	Colour
AR00124	Red
AR00125	Yellow
AR00126	Green
AR00127	Black
AR00128	White
AR00129	Blue
AR00130	Orange
AR00131	Grey

AR00124



**Protective**

Stock Code	Size
AR00102	2"
AR00103	3"
AR00104	4"
AR00105	6"

AR00102



**Silver Duct Tape**

Stock Code	Size
AR00133	2"

AR00133



**Aluminium Foil Tape**

Stock Code	Size
AR00132	2"

AR00132

**2 Ft Pallet Film**  
AR00135

**Denso Tape**

Stock Code	Size
AR00106	1"
AR00107	1 1/2"
AR00108	2"
AR00109	3"
AR00110	4"
AR00111	6"

AR00106



**DeColour Pipe Tape 2"**

Stock Code	Colour
AR00112	Yellow
AR00113	Blue
AR00114	Red
AR00115	Green

AR00112



**Anti Skid Tape**

Stock Code	Size
AR00116	2"
AR00117	3"
AR00118	4"
AR00119	6"

AR00116



Corrugated Paper  
AR00134



Bubble Pak  
AR00136



Linoleum  
AR00137



Angle Board  
AR00138



### Domestic Aluminium A Ladder

Code No.	Step	LGT/mm
AR00204	3	660
AR00205	4	880
AR00206	5	1100
AR00207	6	1320
AR00208	7	1540
AR00209	8	1760
AR00210	9	1980
AR00211	10	2200



AR00204

### Aluminium A Ladder

Code No.	Step	LGT/mm
AR00212	3	800
AR00213	4	1000
AR00214	5	1300
AR00215	6	1500
AR00216	7	1800
AR00217	8	2000
AR00218	9	2300
AR00219	10	2500
AR00220	11	2800
AR00221	12	3000
AR00222	13	3300
AR00223	14	3600
AR00224	15	3800
AR00225	16	4000
AR00226	17	4300
AR00227	18	4600
AR00228	19	4800
AR00229	20	5000
AR00230	21	5250
AR00231	22	5500
AR00232	23	5750
AR00233	24	6000

### Aluminium Single Pole Ladder



Code No.	Step	LGT/mm
AR00234	7	8'/2.5m
AR00235	9	10'/3.0m
AR00236	11	12'/3.6m
AR00237	14	15'/4.5m
AR00238	18	20'/6.0m

### Aluminium Double Extension Ladder

Code No.	Size
AR00239	8' x 8'
AR00240	10' x 10'
AR00241	12' x 12'
AR00242	15' x 15'
AR00243	20' x 20'

### Aluminium Triple Extension Ladder

Code No.	Size
AR00244	8' x 8' x 8'
AR00245	10' x 10' x 10'
AR00246	12' x 12' x 12'
AR00247	15' x 15' x 15'

## Ridgid Aluminium & Extension Ladder

RIDGID ladders are available in aluminium and fiberglass. Meet OSHA requirements and comply with code requirements of the American National Standard Institute. Also meets and exceeds Canadian Standards Association testing requirements.

### Fiberglass Extension Ladders - Type 1A Extra Heavy Duty\*

Feature 'D' rung, outside slide guides and cast aluminium run lock. Pulley and all-weather polypropylene rope are standard. Included are plated steel safety shoes, top and bottom mar-resistant end caps.

### Fiberglass Step Ladders - Type 1A Extra Heavy Duty\*\*

Pinch-resistant spreader braces and skid-resistant rubber feet provide added safety and long service life. Non-conductive solid fiberglass rails. Lightweight for easy handling. Aluminium steps and molded top cap with tool slots.

### Fiberglass Double Step Ladders - Type 1A Heavy Duty\*

Constructed of non-conductive fiberglass for years of service, allowing for entry from either side. Plated steel hinges extend above the top step to provide side guards when using scaffold planks. Pinch-resistant side braces. Aluminium angle feet with heavy duty corrugated rubber tread.

### Step Ladders

Code No.	Model No.	Old Cat. No.	Step Size		Bottom Width		Spread		Weight kg.	Type
			ft.	mm	in.	mm	in.	mm		
AH76682	RL-FGS4	50387	3	76	20.5	520	29	736	7.1	1A
AH76687	RL-FGS5	-	3	76	21.4	543	35	889	8.6	1A
AH76692	RL-FGS6	50392	3	76	24.0	609	41	1041	10.1	1A
AH76697	RL-FGS8	50397	3	76	27.5	698	54	1371	13.8	1A
AH76702	RL-FGS10	50402	3	76	31.0	787	66	1676	17.5	1A
AH76707	RL-FGS12	50407	3	76	34.5	976	78	1981	22.0	1A
AH86937	RL-FD60	50417	3	76	22.9	581	52	1316	10.9	1A
AH86942	RL-FD80	50422	3	76	25.9	657	67	1695	17.7	1A

### Extension Ladders

Code No.	Model No.	Old Cat. No.	Total Length of Sections		Base and Fly Lengths		Fly Width O.D.		Base Width		Max. Extension		Rail Depth		Weight kg.	Type
			ft.	m	ft.	m	in.	mm	ft.	m	ft.	m	in.	mm		
AH76712	RL-FGE16	-	16	4.9	8	2.4	16 <sup>1</sup> / <sub>16</sub>	408	17 <sup>1</sup> / <sub>16</sub>	432	13	4.0	3 <sup>1</sup> / <sub>4</sub>	83	13.4	1A
AH76717	RL-FGE20	50337	20	6.1	10	3.0	16 <sup>1</sup> / <sub>16</sub>	408	17 <sup>1</sup> / <sub>16</sub>	432	17	5.1	3 <sup>1</sup> / <sub>4</sub>	83	16.4	1A
AH76722	RL-FGE24	50342	28	7.3	12	3.6	16 <sup>1</sup> / <sub>16</sub>	408	17 <sup>1</sup> / <sub>16</sub>	432	21	6.4	3 <sup>1</sup> / <sub>4</sub>	83	19.4	1A
AH76727	RL-FGE28	50347	28	8.5	14	4.2	16 <sup>1</sup> / <sub>16</sub>	408	17 <sup>1</sup> / <sub>16</sub>	432	25	7.6	3 <sup>1</sup> / <sub>4</sub>	83	22.0	1A
AH76732	RL-FGE32	50352	32	9.7	16	4.8	16 <sup>1</sup> / <sub>16</sub>	422	17 <sup>1</sup> / <sub>16</sub>	450	29	8.8	3 <sup>1</sup> / <sub>16</sub>	84	26.1	1A
AH76737	RL-FGE36	-	40	12.2	20	6.1	17 <sup>13</sup> / <sub>16</sub>	451	19 <sup>1</sup> / <sub>16</sub>	482	32	9.7	4	101	37.0	1A
AH76742	RL-FGE40	50357	40	12.2	20	6.1	17 <sup>13</sup> / <sub>16</sub>	451	19 <sup>1</sup> / <sub>16</sub>	482	35	10.6	4	101	40.7	1A



Model No. Code  
 FGE - Fiberglass Extension  
 FGS - Fiberglass Step Ladders  
 FD - Fiberglass Double Step Ladders  
 \* Type 1A - 300 lb. workload  
 \*\* Type 1 - 250 lb. workload



### Onishi Explosion Proof Fan

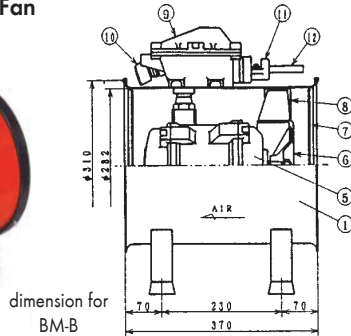

#### Features

- The Lightest Weight: BM-B—25 KG  
BB-B —14.5 KG
- Safety: Exp. Proof Grade d2G4. Non-Sparking Type
- Useful: Fitting with a Exp. Proof Switch Cabtire.  
Cable 5M Length

#### Particulars

Stock Code	Type	Dia:mm	Output	Source	Quantity	Pressure	Weight
AS00008	BM-B	300	0.55kW 1 Ø 50 / 60Hz	AC100V	70m³/min	30mmAq	25kg
AS00009	BB-B	200	0.18kW	AC230V	20m³/min	20mmAq	14kg

### WIND YAMA

WIND YAMA WEV 400 16" and WEV 600 21" variable speed turbo blowers offer more power, higher performance, no CO and are GFCI-compatible, too!

- You Control The 1.5HP Force**  
From full PPV for fast clearance of dangerous smoke and gases to slower speeds for cooling overheated firefighters is as easy as turning the control knob on the control panel.
- IntelliSense™ Controls The Start Up Power**  
This exclusive water-resistant electronic control feature monitors and limits the amount of start up power to allow operation on GFCI Circuits and for starts on generators as small as 2kW.

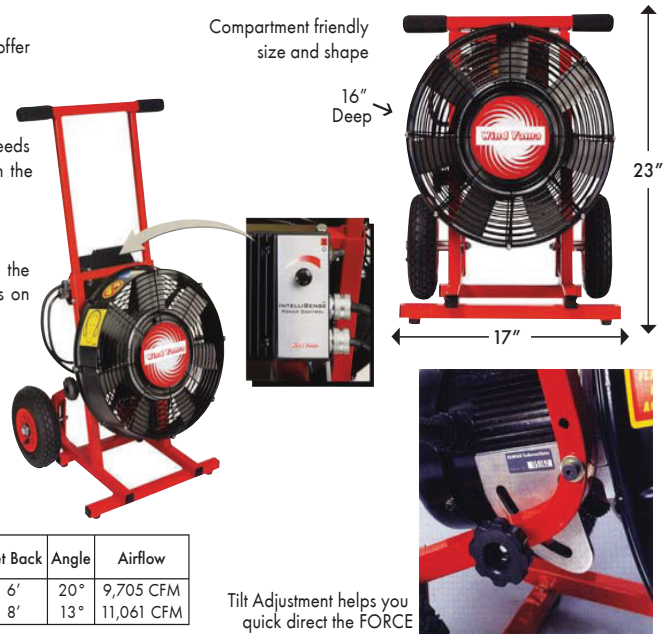

#### Specifications

Stock Code	Model No.	HP	Dimensions	Motor MFG/ Model No.	Wt	RPM	Set Back	Angle	Airflow
AS00355	WEV400-16"	1.5	23H x 17W x 16D	YM-EM-F1.5-90	74	3588	6'	20°	9,705 CFM
AS00356	WEV600-21"	1.5	24H x 18W x 24D	YM-EM-F1.5-90	80	3588	8'	13°	11,061 CFM

### Wind Yama Portable Ventilator



AP-200  
Portable Ventilator  
Size: 8"  
Rotation: 3460rpm  
HP: 150W  
Voltage: Single Phase 110V, 220V  
Three Phase 220V, 380V

AS00003



AP-300  
Portable Ventilator  
Size: 12"  
Rotation: 3460rpm  
HP: 550W  
Voltage:  
Single Phase 110V, 220V  
Three Phase 220V, 380V

AS00004

#### Features

- Aluminium blades compact in size, easy to operate.
- Single-phase condensor motor eliminates the problems of over-heating of three-phase motors.
- Aluminium blades have been subject to balance correction with computer.

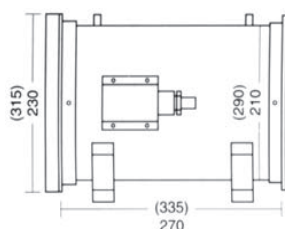

#### For Use In

- Underground tunnels shipyards honeycombed locales & narrow places.
- To suck away toxic gases when welding and keep air fresh.
- Perfect for storage compartments, warehouse and electric cable construction sites.

Stock Code	Model No.	Weight	Voltage	P	Hz	m³/min	m/Aq	r.p.m	pH	kg
AS00003	AP-200	150	110 & 220	2	50	25	35	2,930	1pH	10.3
					60	30	42	3460		
					50	60	40	2,930		
AS00004	AP-300	550	110 & 220	2	50	60	40	2,930	1pH	19.7
					60	70	50	3460		

## Portable Fan



AS00624

Stock Code	Model	Size	Power	Max RPM	Phase	Max Rated
AS00624	AP-2	200mm/8"	1/4HP/230V/50Hz/60Hz	2800 RPM	Single	25m3/min
AS00625	AP-3	300mm/12"	1/4HP/230V/50Hz/60Hz	2800 RPM	Single	63m3/min
AS00627	AP-4	350mm/14"	1.0HP/230V/50Hz/60Hz	2800 RPM	Single	82m3/min

## Jumbo Axial Fan



AS00628

Stock Code	Model	Size	Power	Max RPM	Phase	Max Rated
AS00628	AP-5	400mm/16"	2.0HP/230V/50Hz	2800 RPM	Single	128m3/min
AS00629	AP-6	500mm/20"	2.2HP/230V/50Hz	2800 RPM	Single	138m3/min
AS00630	AF-6	500mm/20"	2.2HP/415V/50Hz	2800 RPM	3Phase	138m3/min

## Portable Fan

AS00623



Stock Code	Model	Size	Power	Max RPM	Phase	Max Rated
AS00623	AP-7	600mm/24"	3.0HP/230V/50Hz	1400 RPM	Single	290m3/min
AS00631	AP-7	600mm/24"	3.0HP/415V/50Hz	1400 RPM	3Phase	290m3/min

## Axial Blowers with Adjustable Stand



AP-206 200mm/8"  
AS00756

AP-306 300mm/12"  
AS00757

## AXIAL FLOW FAN



AS00750

## Axial Flow Fan - Multi Outlet



AS00752

Model: AP-800 Diameter: 800 mm Voltage: 415V~440v Phase: 3 Output: 7.5kw/10HP	Airflow: 35000m3/hr. Speed: 1450rpm Hz: 50 Static Pressure: Pole: 4	GIANT AS00750 AP-800	Multi Outlet AS00752 APMO-800
Model: AP-900 Diameter: 900 mm Voltage: 415V~440V Phase: 3 Output: 7.5kw/10HP	Airflow: 38800m3/hr Speed: 1450rpm Hz: 50 Static Pressure: Pole: 4	GIANT AS00753 AP-900	Multi Outlet AS00756 APMO-900
Model: AP-1000 Diameter: 1000mm Voltage: 415V~440V Phase: 3 Output: 11kw/10HP	Airflow: 46950m3/hr Speed: 1450rpm Hz: 50 Static Pressure: Pole: 4	GIANT AS00704 AP-1000	Multi Outlet AS00754 APMO-1000
Model: AX-1100 Diameter: 1100mm Voltage: 415V~440V Phase: 3 Output: 11kw/15HP	Airflow: 64325m3/hr. Speed: 1450rpm Hz: 50 Static Pressure: Pole: 4	GIANT AS00751 AP-1100	Multi Outlet AS00755 APMO-1100

## 12" Pneumatic Typhoon Blower



AS00325

Stock Code	Model	Motor	Power Cord	Switch
AS00325	AP-9	1.0H.P. PNEUMATIC	-	Single

Size	Max Rated	Wheel Speed	Meas	Weight
12" (300mm)	2200CFM	3250 RPM	49.5*38.5*52cm	12.0kgs

## CARPET BLOWER

Stock Code	Model	Motor	Power Cord	Switch	Blade Diameter
AS00743	AP 10	1/2 H.P 230V/50Hz	1.00mm2	three	Ø241 * 237mm
AS00745	AP 11	1/3 H.P 115V/60Hz	#18-3	three	Ø241 * 237mm

Max Rated	Wheel Speed	Meas	Weight
1750 CFM	1100/1000/ 900 RPM	50*42.5*49 cm	14.0KGS
1258CFM	1100/1000/ 900 RPM	50*42.5*49 cm	13.0 kgs

AS00745



## Ventilation Hose (5 MTR/10 MTR)



AS00016

Flexible Duct  
Dia:  
From 180m/m - 1000m/m  
Length Measure:  
From 1m - 20m



Connection Flexible Duct  
Easily fitted extensions can extend the duct. Simply slip the extension over the ring on the end of the duct and securely tie the cord

### 5 MTR

Stock Code	Size
AS00016	200mm/8"
AS00017	300mm/12"
AS00018	350mm/14"
AS00019	400mm/16"
AS00020	500mm/20"
AS00021	600mm/24"
AS00565	800mm/32"

### 10 MTR

Stock Code	Size
AS00366	200mm/8"
AS00124	250mm/10"
AS00367	300mm/12"
AS00368	400mm/16"
AS00369	500mm/20"
AS00370	600mm/24"
AS00566	800mm/32"
AS00574	900mm/36"
AS00575	1000mm/40"

## WELD MASTER

ALLINTON ENGINEERING & TRADING PTE LTD  
331 Jalan Besar Singapore 208983  
T65 6296 0679 W allinton.com.sg E sales@allinton.com.sg